

[www.ukinox.co.uk](http://www.ukinox.co.uk)



STAINLESS  
STEEL  
COLORX NANO  
GRANITE  
GLASS  
KITCHEN  
SINKS

**UKINOX**

# Kitchen sinks surfaces



## Stainless Steel

UKINOX offers sinks in a selection of stainless steel finishes, so whether you prefer the more reflective qualities of the polished finish or the more subtle look of the silk or brushed finishes, which give a more matt sheen, there is a stainless steel solution for you.



P /  
Polished

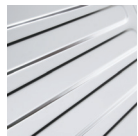

S /  
Satin

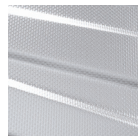

L /  
Linen  
Textured  
Surface

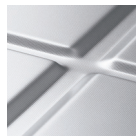

LM /  
Micro Linen  
Textured  
Surface

## Color X

The PVD finish is obtained through a physical, non-chemical process with superior resistance to any other treatment.

Exceptional Surface hardness  
Resistance to wear and abrasion  
Resistance to corrosion, solvents, detergents, foods with high acidity UV  
Inalterability  
Irrelevant ecological impact



Gold

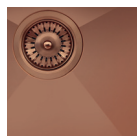

Rose Gold



Titanium



Black

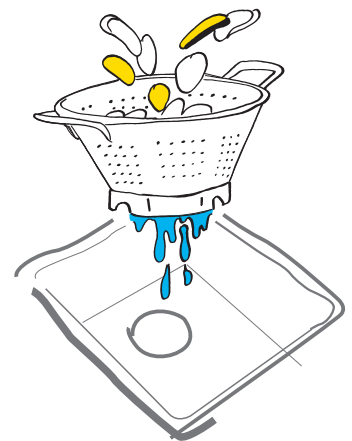

## Granite

Granite contains around 80% granite particles which give it its enormous strength and resistance to...

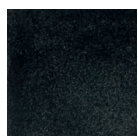

Onyx

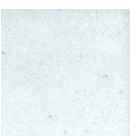

Snova

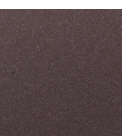

Espresso



Colorado



Grey

## Glass

UKINOX uses a combination of toughened safety glass and stainless steel bowls.

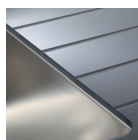

Black



White

# How To clean your Ukinox kitchen sinks

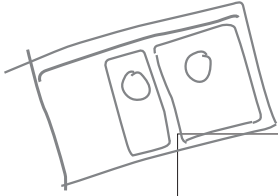

## Granite

Granite kitchen sinks are made from granite and composite material. With regular use, food particles, soap scum, limescale and buildup can occur in the sink. Granite composite sinks require the use of mild cleaning products to prevent damage to their finish.

Wipe the sink thoroughly with warm water and a few drops of dish soap on a cloth to remove light buildup. Rinse it thoroughly and dry with a cloth.

Remove tough stains with cream cleanser and a nylon brush or scrubbing pad. Scrub the sink in a circular motion to remove the stains. Rinse well and dry the sink with a cloth.

Remove limescale buildup by soaking 3 parts water and 1 part vinegar in the sink for a few minutes. Drain the sink and scrub the deposits with a nylon brush or scrubbing pad. Rinse the sink thoroughly and dry it with a cloth.

## Glass

Clean glass sinks regularly to avoid mineral or bacteria buildup. Don't forget to clean the outside of the sink as well! Spots or fingerprints can be cleaned by using a standard glass cleaner. If a glass cleaner is not available, a mixture of vinegar and water will also work. Use a non-abrasive cloth to wipe the sink clean and rinse well. Abrasive cleaners or scouring pads may scratch the glass. Take care when cleaning the exterior of a glass sink as it might have a foil or printed application that could be damaged by scrubbing.

Extremely hot water may cause the sink to crack or shatter. As a general rule, if the water is too hot to the touched, then it is too hot to a glass sink.

## Stainless steel

A kitchen sink is a heavy-duty utensil and may show traces of wear over time. Regular cleaning to remove dirt is the best form of maintenance for your sink and will extend its life and beauty. Observe this guide to the use and care of our stainless steel or granite sinks for best results.

Keep the sink dry. Regularly rinse and towel dry your sink with a soft, dry cloth when not in use to keep it dry. This will prevent surface deposits and water spots caused by lime in the water.

Use non-abrasive cleansers. Do not use strong abrasive cleansers or cleansers that contain chlorine (usually sodium hypochlorite) or hydrochloric acid, steel wool or metal scrub pads-these will scratch and dull the surface of the sink.

Rinse away cleansers after use and wipe the sink dry again to prevent water spots from forming.

Do not pour paint into your sink. The chemicals in acrylic paint will react with granite sinks if allowed to sit over 24 hours and will produce permanent marks. For latex-based paints, try removing any residue immediately using a paint remover manufactured by the same brand. Consult the paint remover recommendations before using on any sink.

Use vinegar and water in a mild solution to remove any mineral deposits that may have built up.

## colorX

PVD (Physical Vapor Deposition) uses a state-of-the-art process that molecularly bonds the finish to the faucet, creating a super-hard surface that is, by far, the most durable available today. These cutting edge finishes are so effective, we guarantee them for life against tarnishing.

Avoid all products designed to remove tarnish or rust, and contain hydrochloric, hydrofluoric, and/or phosphoric acid or caustic agents. Avoid bleach. Avoid scouring pads.

Wipe the sink dry after each use to avoid spots, especially if you have hard water. Water spots caused by hard water can create mineral stains that cannot be removed.

Do not store heavy or sharp objects above glass sinks. If they fall, they can scratch or shatter the sink. A chipped or cracked glass sink cannot be repaired.



modern design

PVD finish **ColorX**

hygiene durability

stylish accessories

cutting boards in the ideal size for your sink.



ideal stainless steel  
AISI 304  
BA or BA Linen  
18/8 Cr-Ni.

premium quality chrome nickel steel makes sinks highly resistant to staining, rust and corrosion

- naturally hygienic, it doesn't harbor bacteria
- stainless steel surfaces develop a passive protective layer that continuously renews, so your sink is easy to clean and care for
- durable: temperature and acid resistant
- 100% recyclable

Space saving  
The product fits neatly into the back of the cabinet and the design means that you can use more of the available space for storage.

# Everything starts with an idea

The faucet is one of the most constantly used items in your kitchen. So we place huge importance on creating easy-to-use products that stand the test of time.

The versatile Roller Mat acts as an in-sink metal rack for rinsing as well as a drying rack or a trivet to protect surfaces against hot dishes. simply roll up for easy storage.

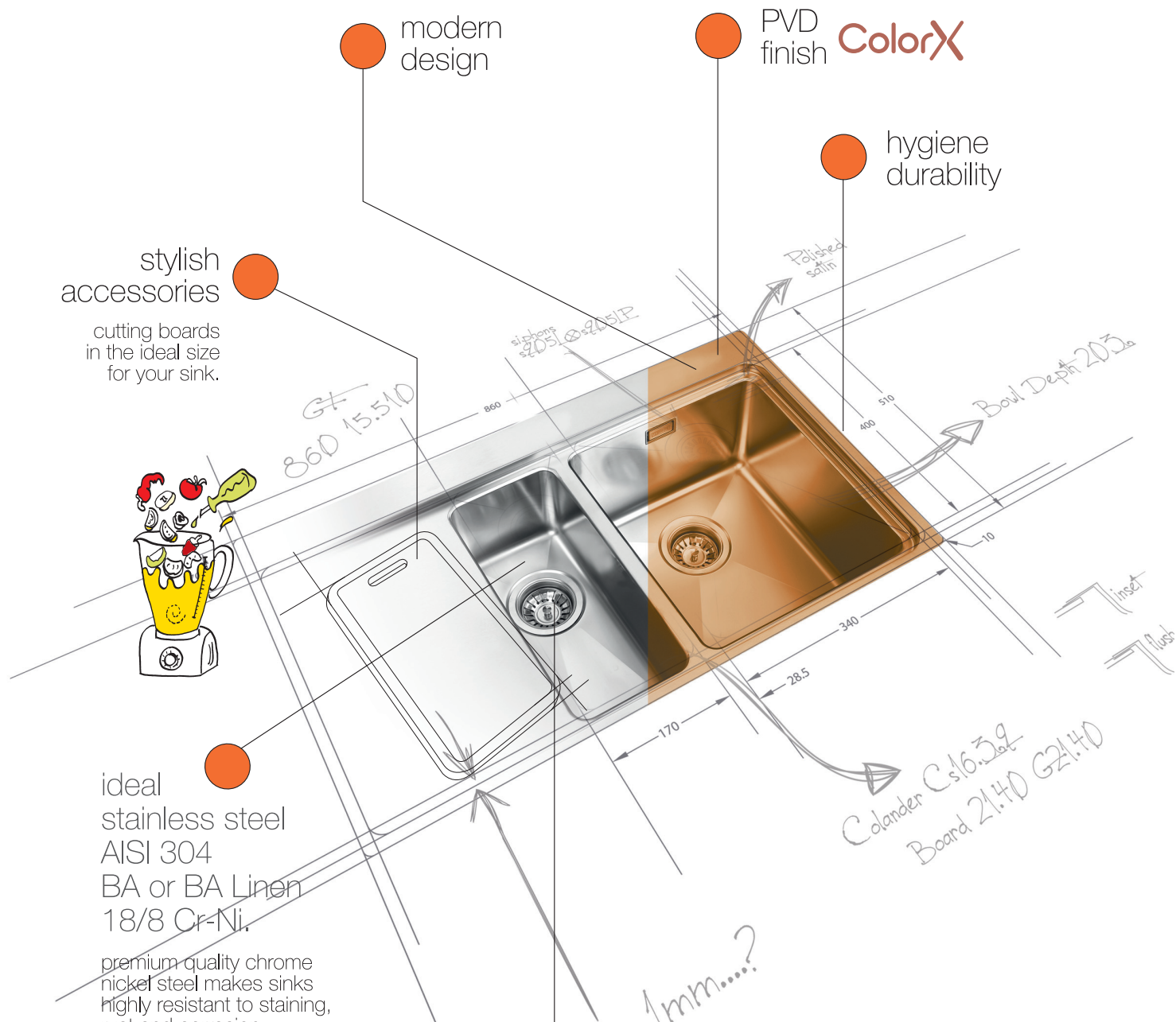



your  
lifestyle  
and your  
personal  
style.



it's part  
of  
the  
family

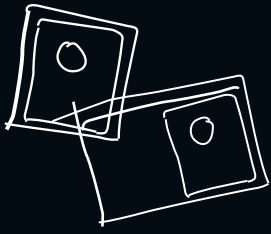

# Kitchen sinks *installation*



Inset



Inset Slim-Top



Flush mount



Out Set



Undermount



## UK INOX

|                   |            |       |
|-------------------|------------|-------|
| Micro Series      | <b>R20</b> | 7-13  |
| TNL Series        | <b>R10</b> | 14-16 |
| Zeroline Series   | <b>R0</b>  | 17-18 |
| ColorX TNL Series | <b>R10</b> | 19-22 |
| Lines Series      |            | 24-25 |
| Undermount Series | <b>R50</b> | 26-28 |
| Glass Series      |            | 29-30 |

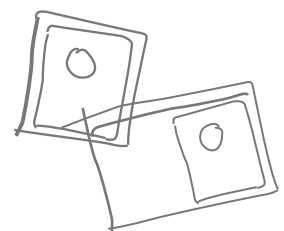

# ME 340

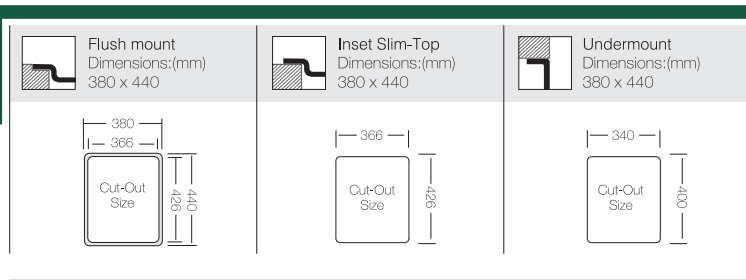

Bowl Size | 340 mm x 400 mm  
 Thickness | 1 mm  
 Sink Depth | 215 mm  
 Finishing | Polished

**SR55**

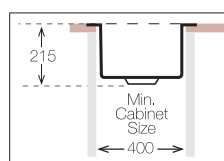
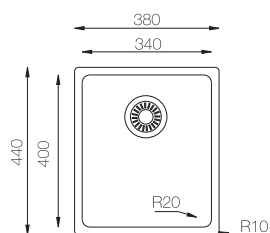

# ME 400

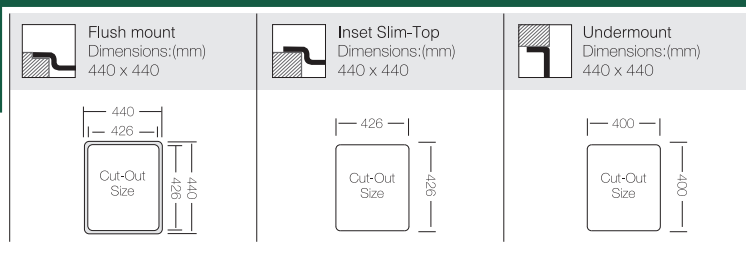

Bowl Size | 400 mm x 400 mm  
 Thickness | 1 mm  
 Sink Depth | 215 mm  
 Finishing | Polished

**SR60**

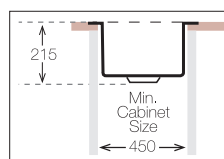
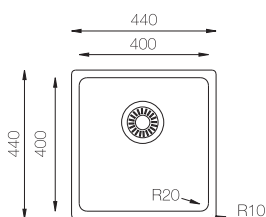



**ME 450**

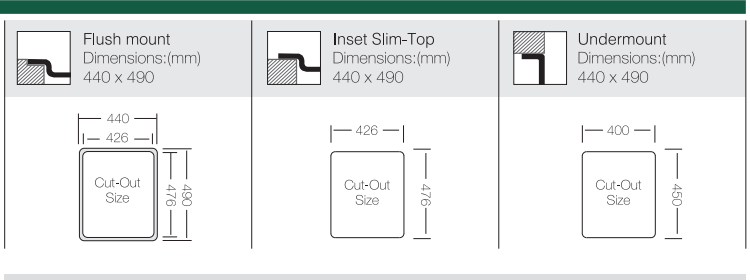

Bowl Size | 400 mm x 450 mm  
 Thickness | 1 mm  
 Sink Depth | 215 mm  
 Finishing | Polished  
**SR65**

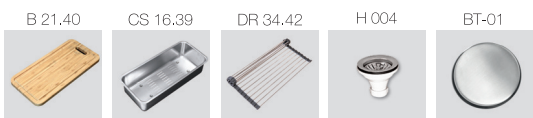
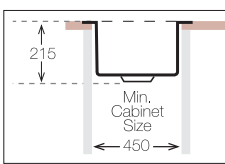
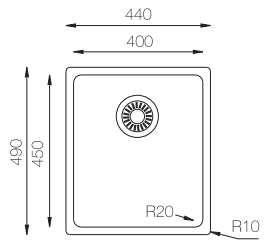

**ME 500**

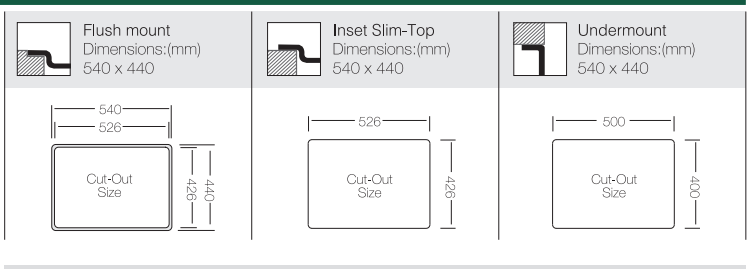

Bowl Size | 500 mm x 400 mm  
 Thickness | 1 mm  
 Sink Depth | 215 mm  
 Finishing | Polished  
**SR75**

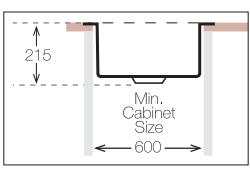
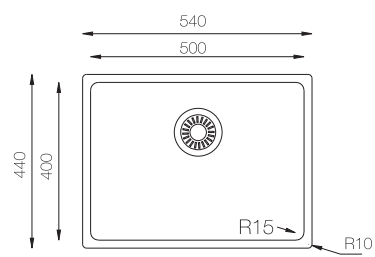

**ME 500.500**

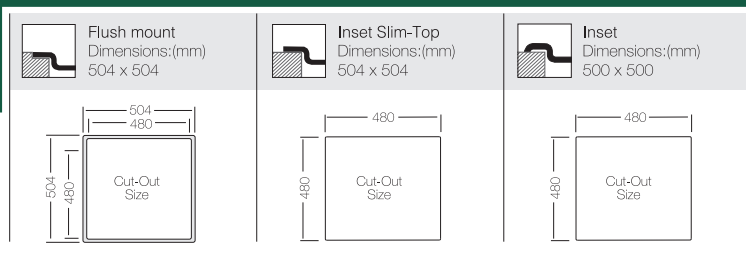
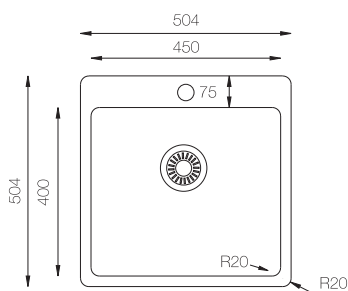

Bowl Size | 450 mm x 400 mm  
 Thickness | 1 mm  
 Sink Depth | 228 mm  
 Finishing | Polished  
**SR80**

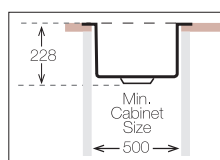

**ME 600.500**

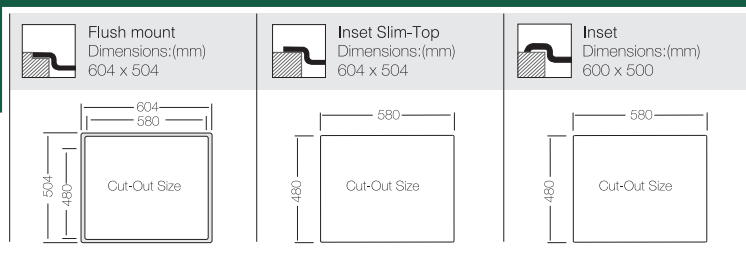
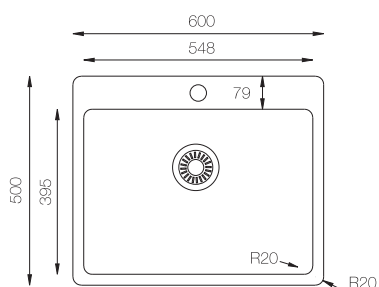

Bowl Size | 548 mm x 395 mm  
 Thickness | 1 mm  
 Sink Depth | 228 mm  
 Finishing | Polished  
**SR85**

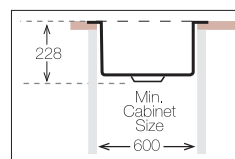

# ME 745

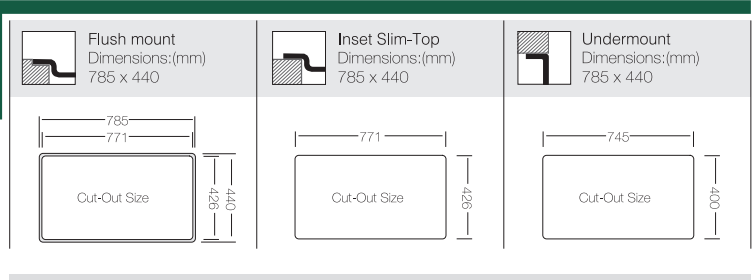

Bowl Size | 745 mm x 400 mm  
 Thickness | 1 mm  
 Sink Depth | 215 mm  
 Finishing | Polished  
**SR100**

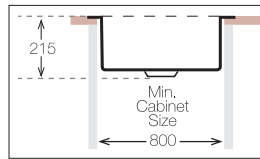
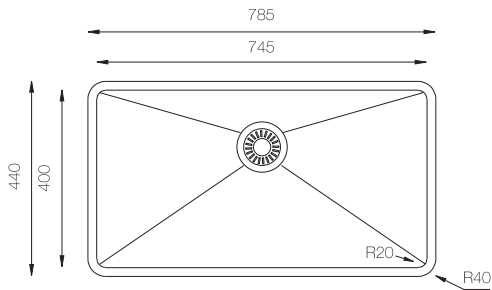

# MU 340.70.30

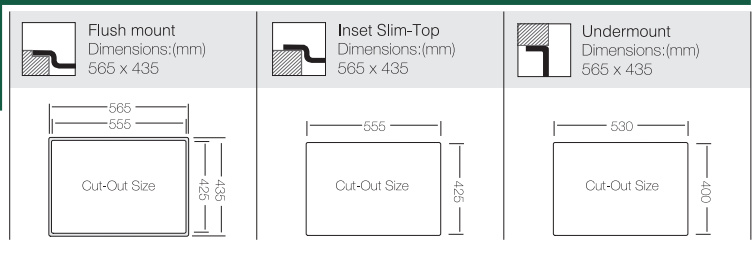

Bowl Size | 340 mm x 400 mm  
 170 mm x 400 mm  
 Thickness | 1 mm  
 Sink Depth | 215 mm  
 Finishing | Polished  
**SR110**

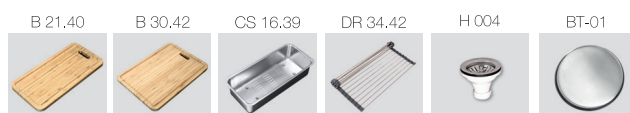
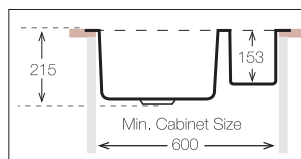
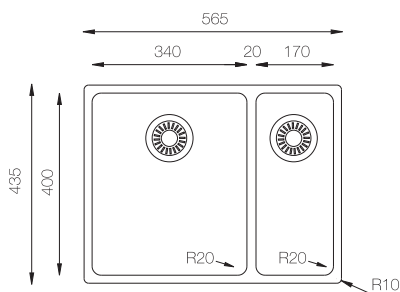

# MM 1000.510

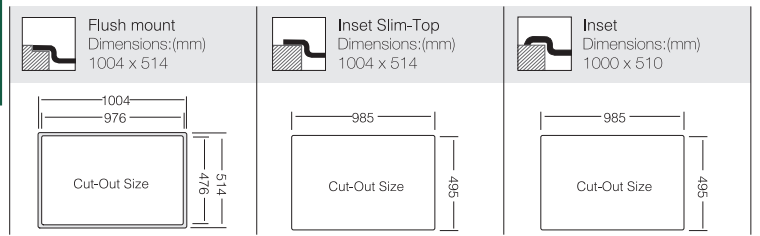
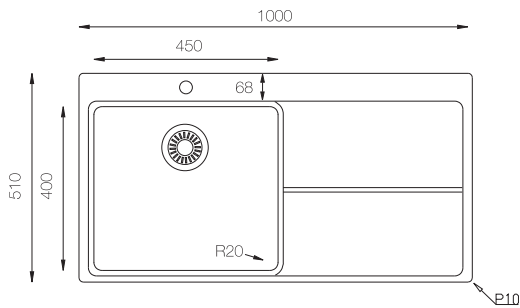

Bowl Size | 450 mm x 400 mm  
 Thickness | 1 mm  
 Sink Depth | 240 mm  
 Finishing | Polished  
**SR115**

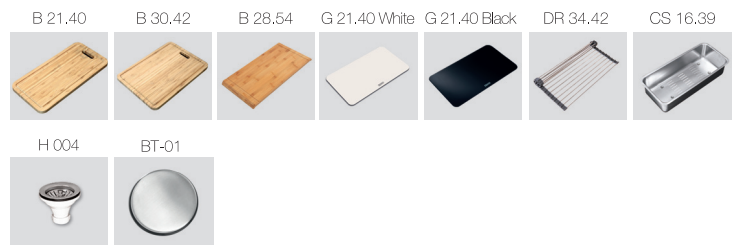
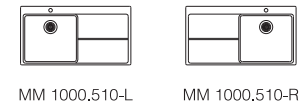
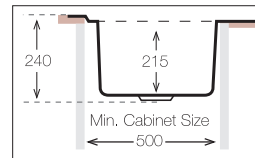

# MM 1000.510.15

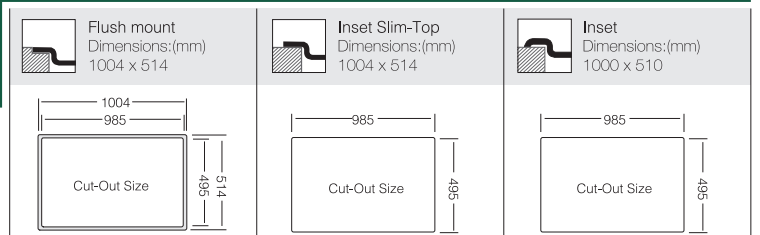
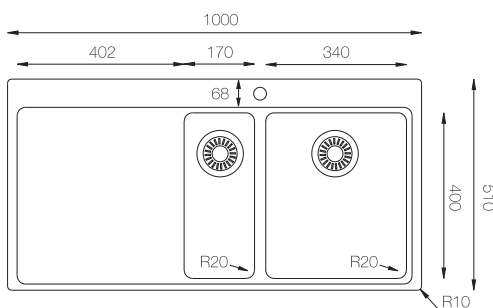

Bowl Size | 340 mm x 400 mm  
 170 mm x 400 mm  
 Thickness | 1 mm  
 Sink Depth | 240 mm  
 Finishing | Polished  
**SR140**

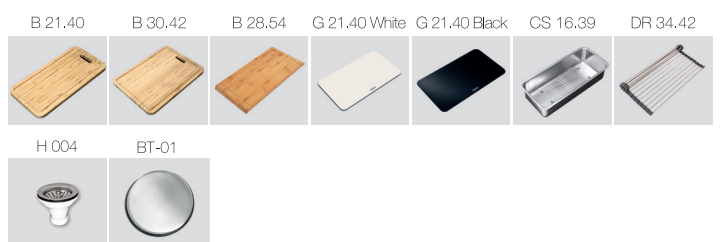
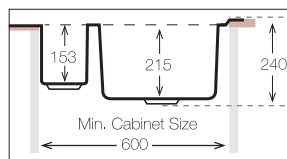



# MF 860.500

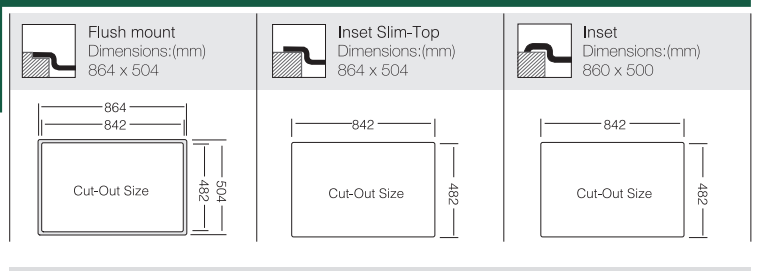

Bowl Size | 400 mm x 400 mm  
 Thickness | 1 mm  
 Sink Depth | 240 mm  
 Finishing | Polished  
**SR105**

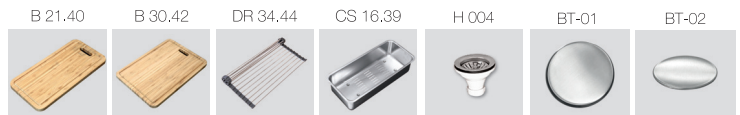
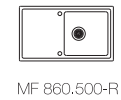
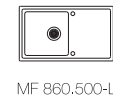
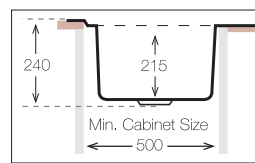
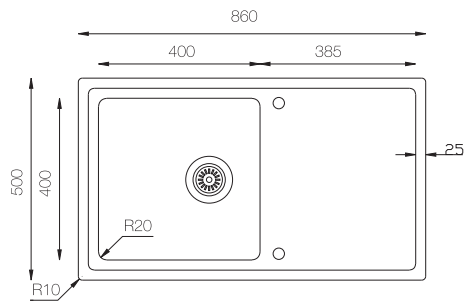

# MF 1000.500.15

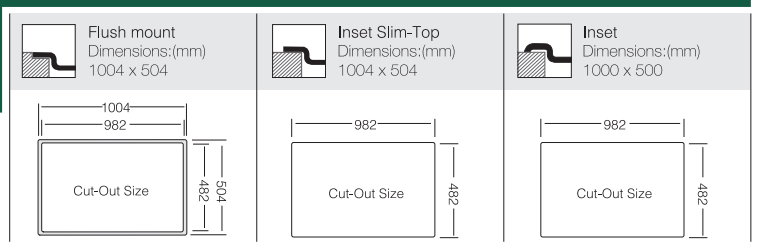

Bowl Size | 340 mm x 400 mm  
 170 mm x 300 mm  
 Thickness | 1 mm  
 Sink Depth | 240 mm  
 Finishing | Polished  
**SR125**

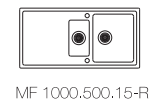
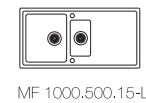
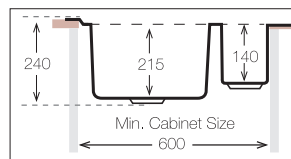
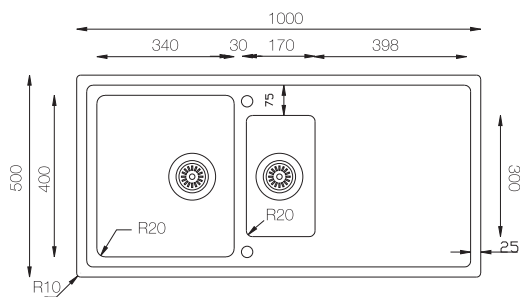

**TNL 400** HANDMADE

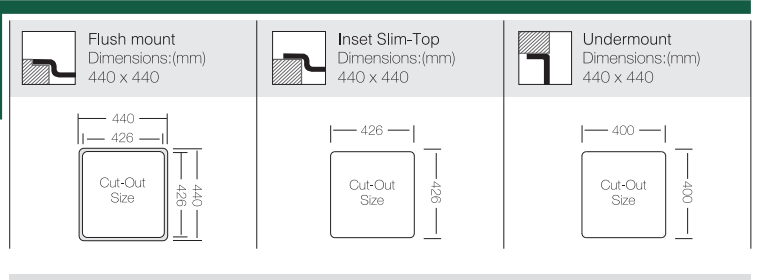

Bowl Size | 400 mm x 400 mm  
 Thickness | 1,2 mm  
 Sink Depth | 203 mm  
 Finishing | Polished  
**SR100**

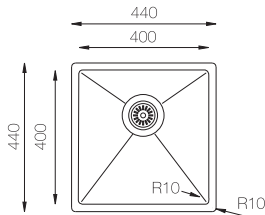
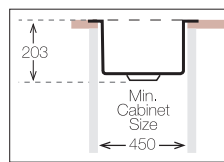

**TNL 500** HANDMADE

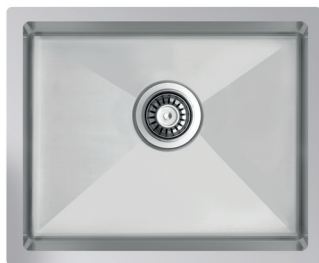
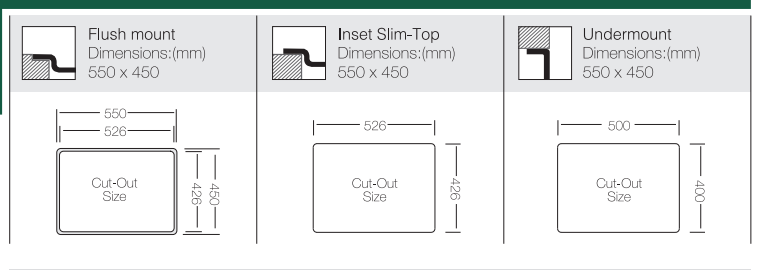

Bowl Size | 500 mm x 400 mm  
 Thickness | 1,2 mm  
 Sink Depth | 203 mm  
 Finishing | Polished  
**SR110**

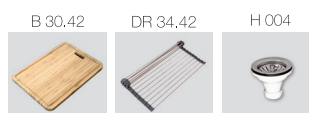
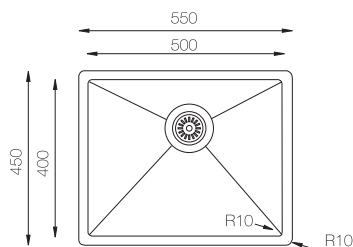
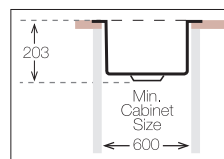

**TNL 745** HANDMADE

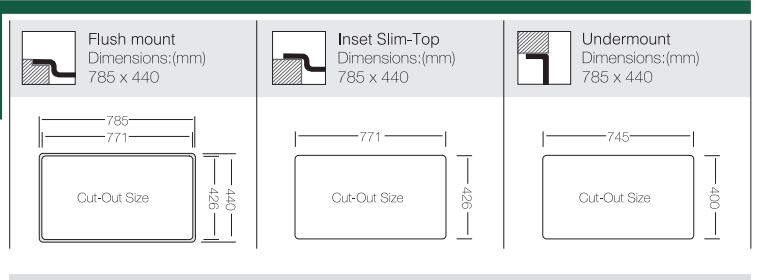

Bowl Size | 745 mm x 400 mm  
 Thickness | 1.2 mm  
 Sink Depth | 203 mm  
 Finishing | Polished

**SR135**

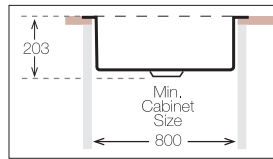
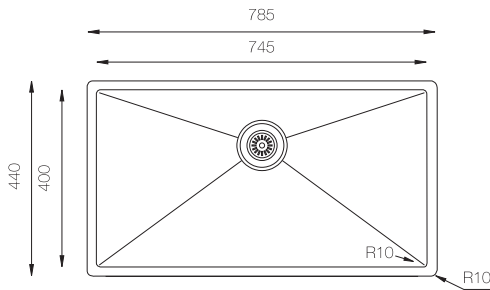

**TNL 450.505** HANDMADE

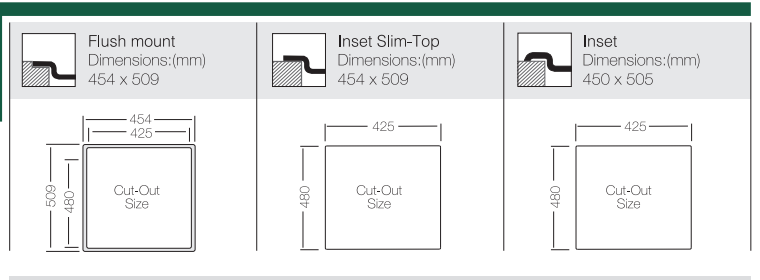

Bowl Size | 400 mm x 400 mm  
 Thickness | 1.2 mm  
 Sink Depth | 203 mm  
 Finishing | Polished

**SR115**

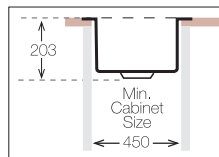
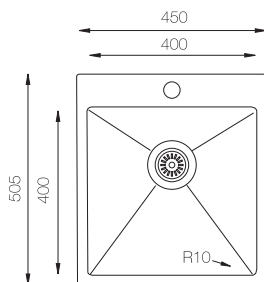



TNL 550.505

HANDMADE

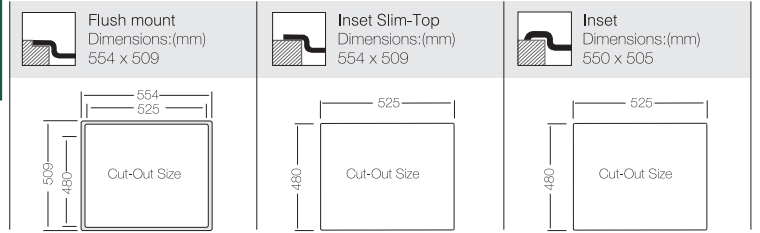

Bowl Size | 450 mm x 400 mm  
 Thickness | 1.2 mm  
 Sink Depth | 203 mm  
 Finishing | Polished

**SR120**

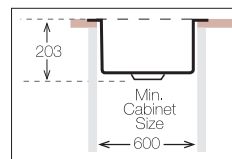
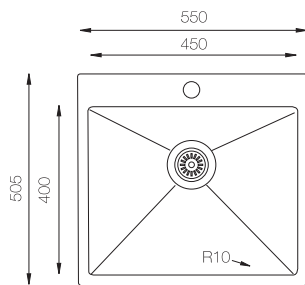

ZRL 340

HANDMADE

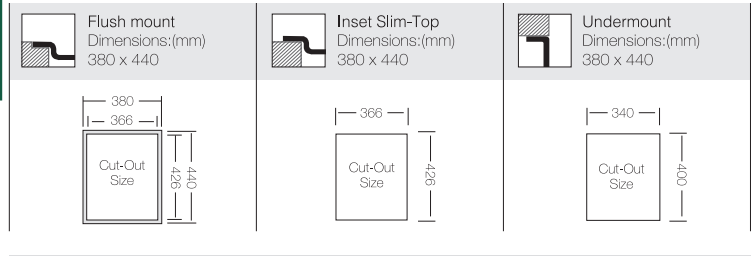

Bowl Size | 340 mm x 400 mm  
 Thickness | 1.2 mm  
 Sink Depth | 203 mm  
 Finishing | Polished  
**SR85**

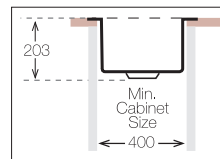
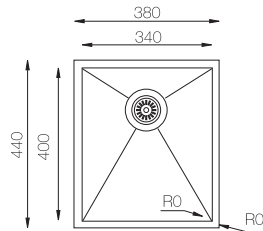

ZRL 400

HANDMADE

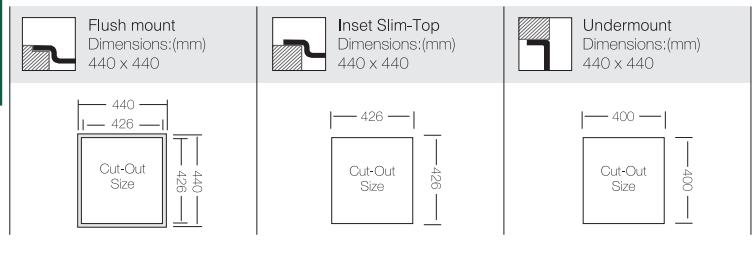

Bowl Size | 400 mm x 400 mm  
 Thickness | 1.2 mm  
 Sink Depth | 203 mm  
 Finishing | Polished  
**SR90**

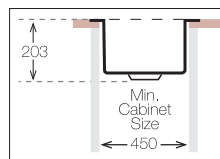
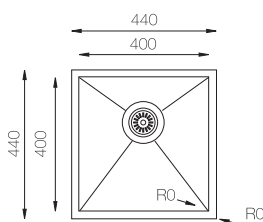

ZRL 500

HANDMADE

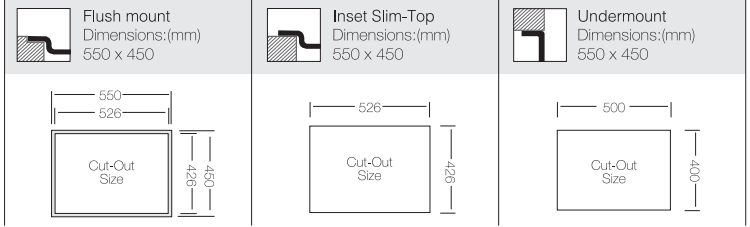

Bowl Size | 500 mm x 400 mm  
 Thickness | 1.2 mm  
 Sink Depth | 203 mm  
 Finishing | Polished  
**SR100**

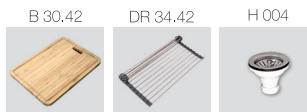
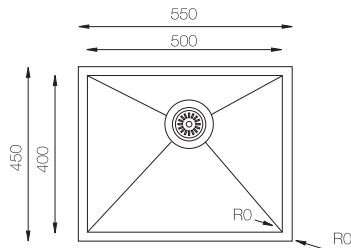
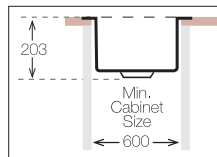

**ColorX TNL400**

HANDMADE

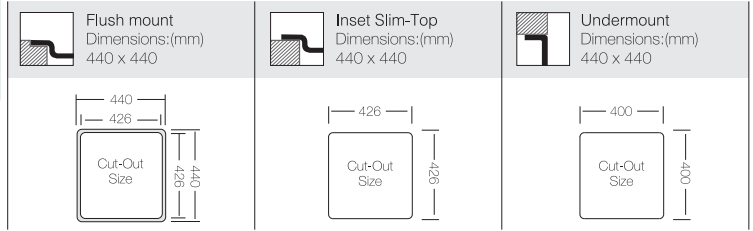

Bowl Size | 400 mm x 400 mm  
 Thickness | 1.2 mm  
 Sink Depth | 203 mm  
 Finishing | Polished

Gold



Rose Gold



Titanium



Black

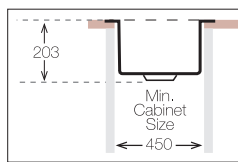
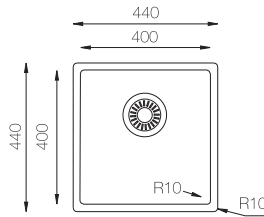

**ColorX TNL500**

HANDMADE

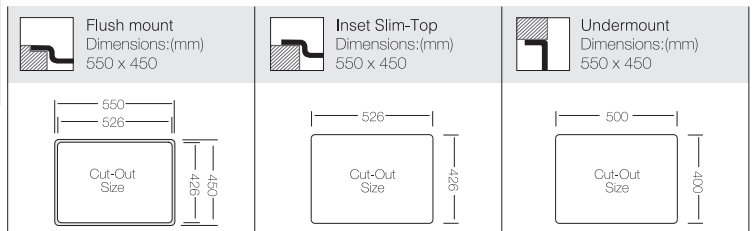

Bowl Size | 500 mm x 400 mm  
 Thickness | 1.2 mm  
 Sink Depth | 203 mm  
 Finishing | Polished

Gold



Rose Gold



Titanium



Black

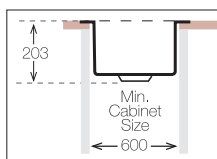
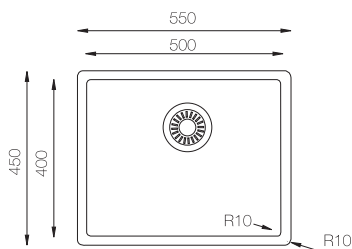

**ColorX TNL745**

HANDMADE

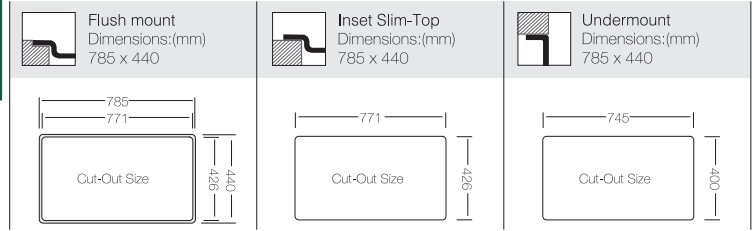
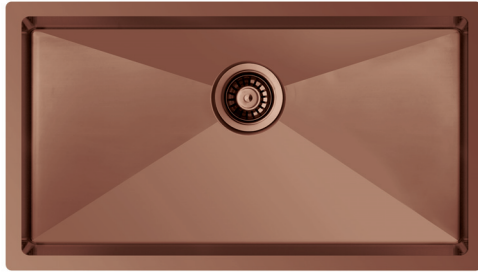

Bowl Size | 745 mm x 400 mm  
 Thickness | 1.2 mm  
 Sink Depth | 203 mm  
 Finishing | Polished

Gold



Rose Gold



Titanium



Black

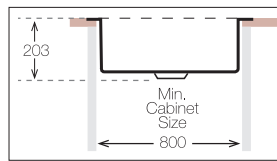
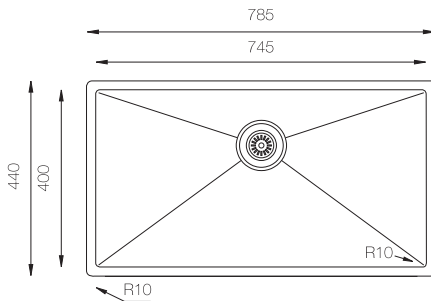

**ColorX TNL 450.505**

HANDMADE

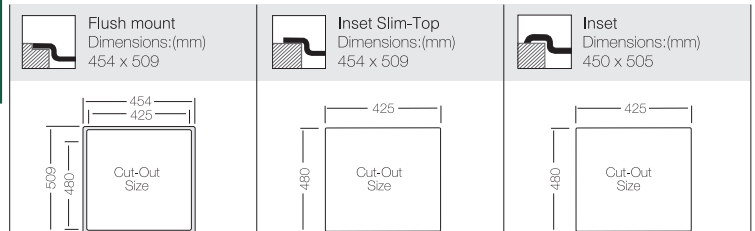

Bowl Size | 450 mm x 505 mm  
 Thickness | 1.2 mm  
 Sink Depth | 203 mm  
 Finishing | Polished

Gold



Rose Gold



Titanium



Black

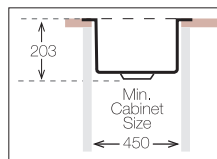
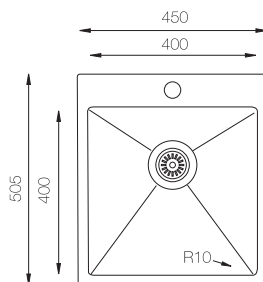

**ColorX TNL 550.505**

HANDMADE



Gold



Rose Gold



Titanium



Black

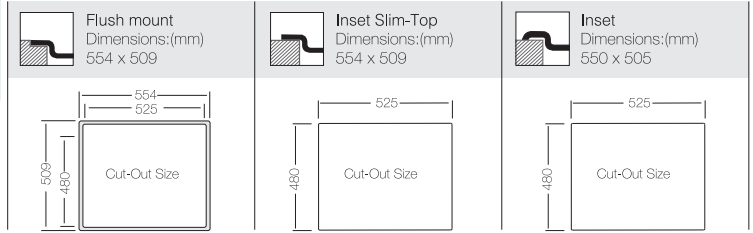
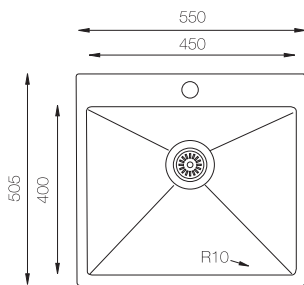

Bowl Size | 505 mm x 550 mm  
 Thickness | 1.2 mm  
 Sink Depth | 203 mm  
 Finishing | Polished

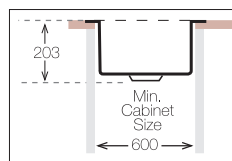

**ColorX TNL340.70.30**

HANDMADE



Gold



Rose Gold



Titanium



Black

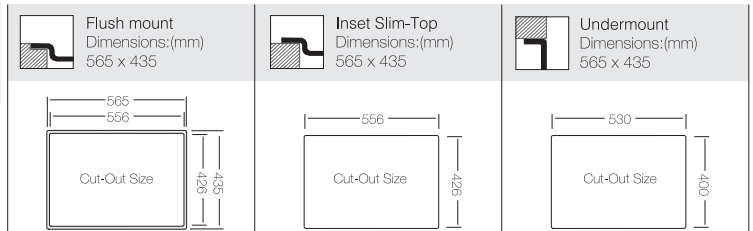
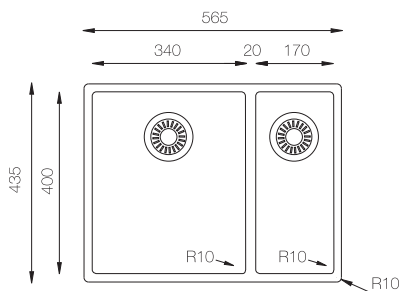

Bowl Size | 340 mm x 400 mm  
 | 170 mm x 400 mm  
 Thickness | 1.2 mm  
 Sink Depth | 203 mm  
 Finishing | Polished

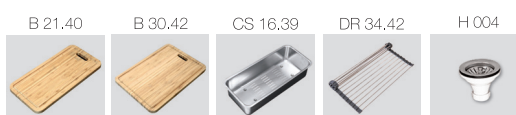
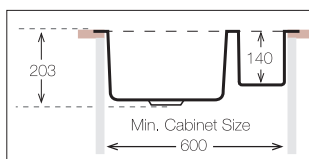

**ColorX TNLP 340.50.50**

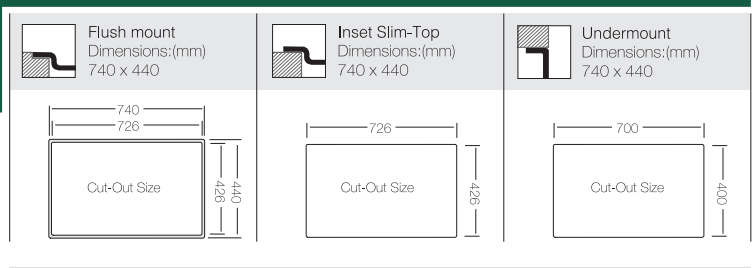

Bowl Size | 340 mm x 400 mm  
340 mm x 400 mm  
Thickness | 1.2 mm  
Sink Depth | 203 mm  
Finishing | Polished

Gold



Rose Gold



Titanium



Black

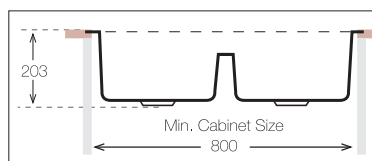
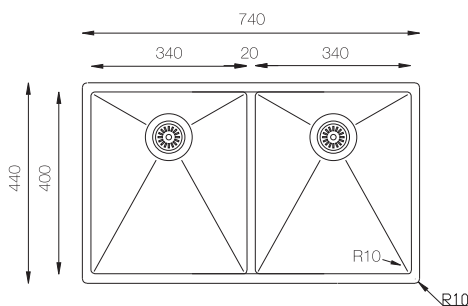

**ColorX**

The PVD finish is obtained through a physical, non-chemical process with superior resistance to any other treatment.

- Exceptional Surface hardness
- Resistance to wear and abrasion
- Resistance to corrosion, solvents, detergents, foods with high acidity UV
- Inalterability
- Irrelevant ecological impact

PVD (Physical Vapor Deposition) uses a state-of-the-art process that molecularly bonds the finish to the faucet, creating a super-hard surface that is, by far, the most durable available today. These cutting edge finishes are so effective, we guarantee them for life against tarnishing.

Avoid all products designed to remove tarnish or rust, and contain hydrochloric, hydrofluoric, and/or phosphoric acid or caustic agents. Avoid bleach. Avoid scouring pads.

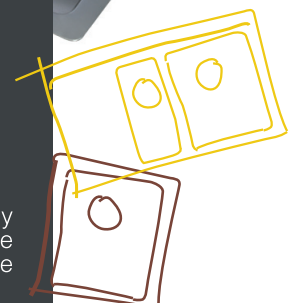





**LN 860.500** MONOBLOCK

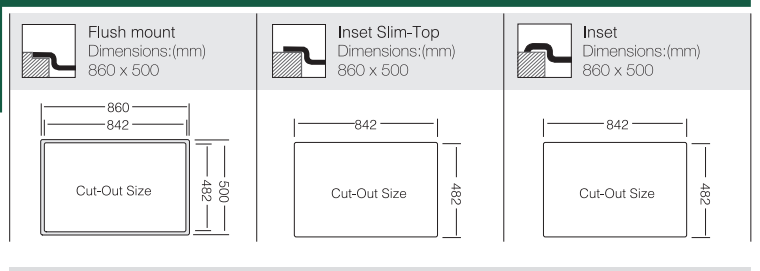

Bowl Size | 340 mm x 420 mm  
 Thickness | 0.70 mm  
 Sink Depth | 185 mm  
 Finishing | Polished / Linen  
**SR60**

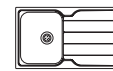
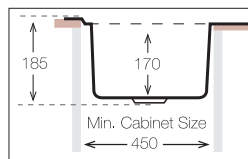
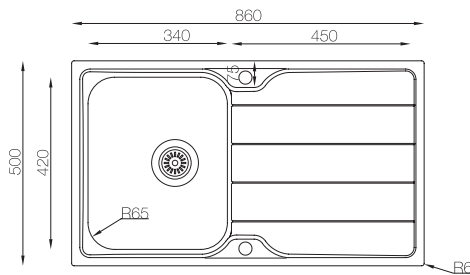

LN 860.500-L

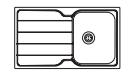

LN 860.500-R

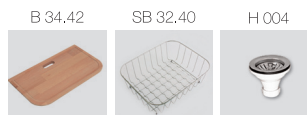

**LN 1000.500** MONOBLOCK

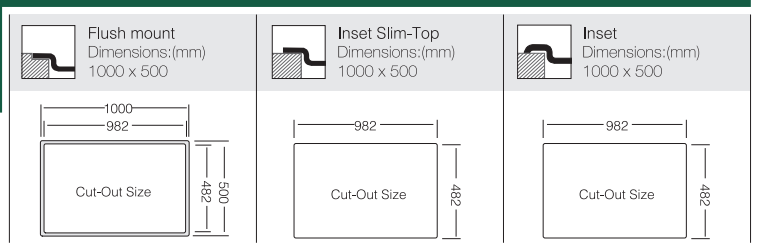

Bowl Size | 450 mm x 400 mm  
 Thickness | 0.70 mm  
 Sink Depth | 185 mm  
 Finishing | Polished / Linen  
**SR65**

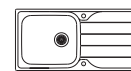
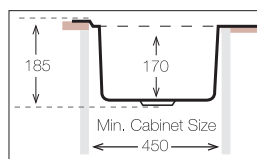
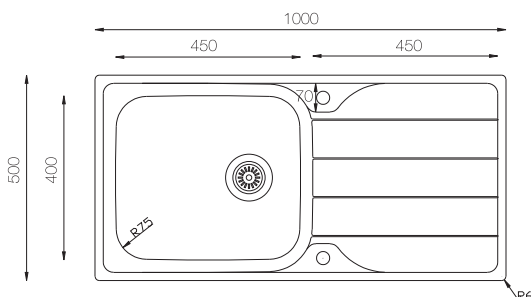

LN 1000.500-L

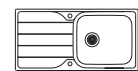

LN 1000.500-R



# LN 1000.500.15

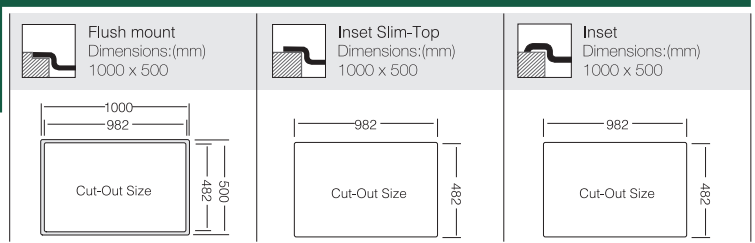

Bowl Size | 340 mm x 420 mm  
 170 mm x 320 mm  
 Thickness | 0.70 mm  
 Sink Depth | 185 mm  
 Finishing | Polished / Linen  
**SR70**

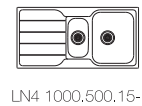
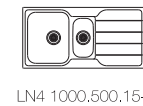
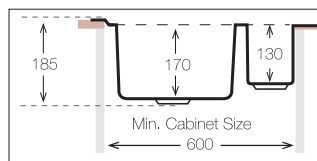
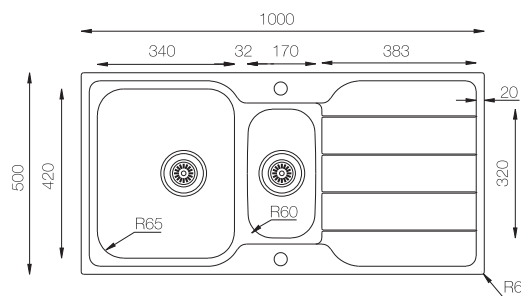

## D 340

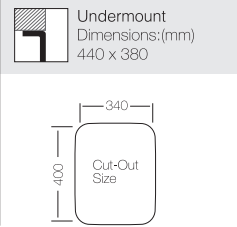

Bowl Size | 340 mm x 400 mm  
 Thickness | 0.80 mm  
 Sink Depth | 190 mm  
 Finishing | Polished  
**SR40**

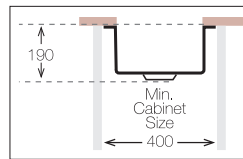
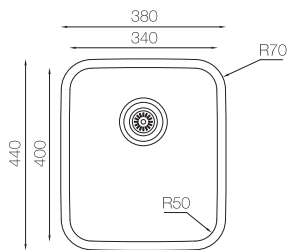

## D 400

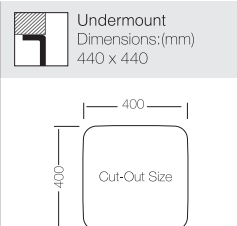

Bowl Size | 400 mm x 400 mm  
 Thickness | 0.80 mm  
 Sink Depth | 190 mm  
 Finishing | Polished  
**SR45**

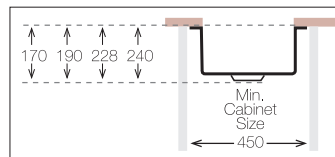
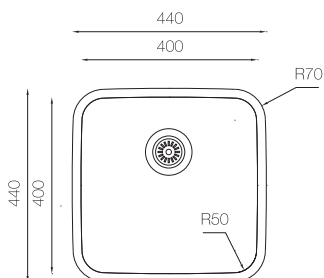

## D 450

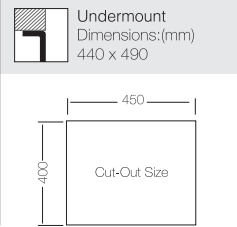

Bowl Size | 450 mm x 400 mm  
Thickness | 0.80 mm  
Sink Depth | 190 mm  
Finishing | Polished

**SR45**

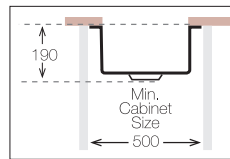
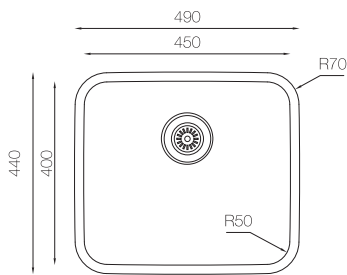

H004



## D 500

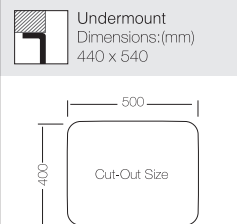

Bowl Size | 500 mm x 400 mm  
Thickness | 0.80 mm  
Sink Depth | 190 mm  
Finishing | Polished

**SR50**

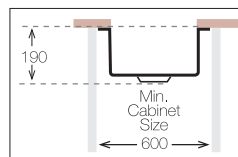
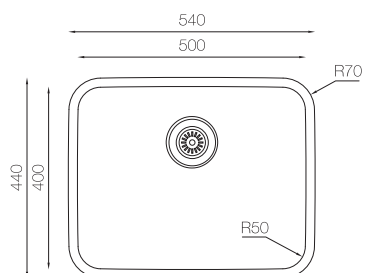

H004



D 340.50.50

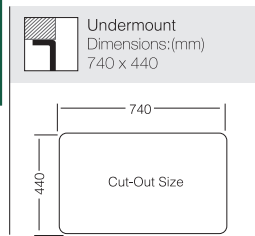

|            |                 |
|------------|-----------------|
| Bowl Size  | 340 mm x 400 mm |
|            | 340 mm x 400 mm |
| Thickness  | 0,80 mm         |
| Sink Depth | 190 mm          |
| Finishing  | Polished        |
|            | <b>SR90</b>     |

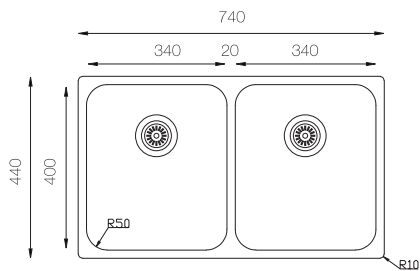
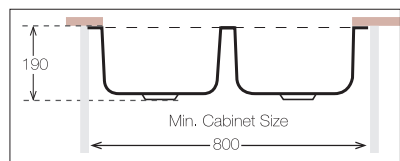

**GS 860.500 W** Crystal

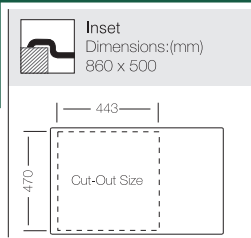

Bowl Size | 340 mm x 400 mm  
Thickness | 1 mm  
Sink Depth | 215 mm  
Finishing | Polished  
**SR170**

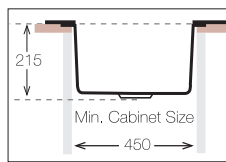
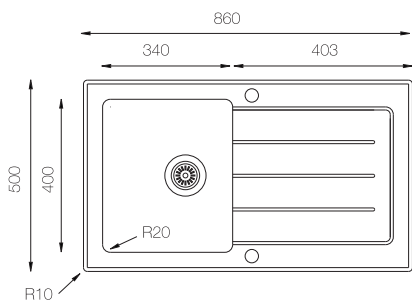

**GS 860.500 B** Crystal

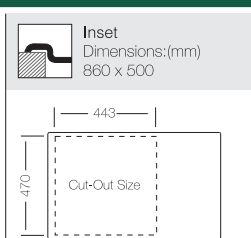

Bowl Size | 340 mm x 400 mm  
Thickness | 1 mm  
Sink Depth | 215 mm  
Finishing | Polished  
**SR155**

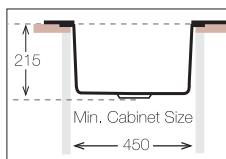
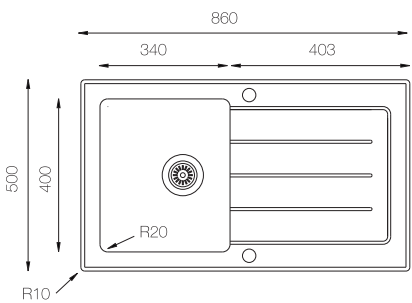

**GS 1000.500.15 W** Crystal

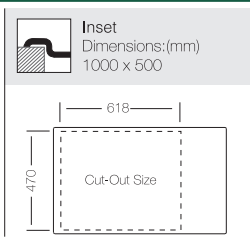

Bowl Size | 340 mm x 400 mm  
170 mm x 400 mm  
Thickness | 1 mm  
Sink Depth | 215 mm  
Finishing | Polished  
**SR285**

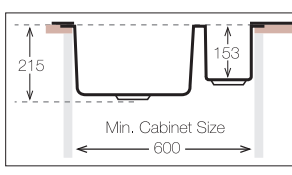
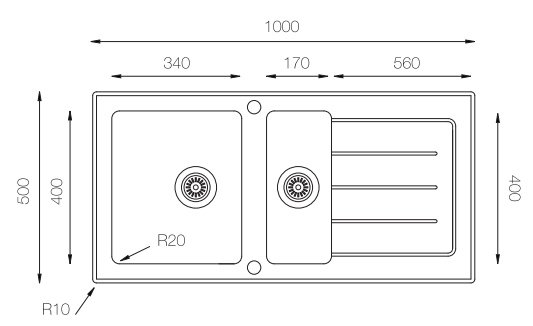

**GS 1000.500.15 B** Crystal

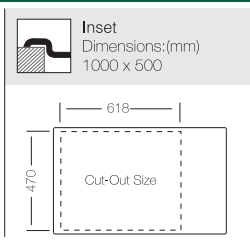

Bowl Size | 340 mm x 400 mm  
170 mm x 400 mm  
Thickness | 1 mm  
Sink Depth | 215 mm  
Finishing | Polished  
**SR270**

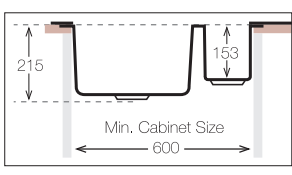
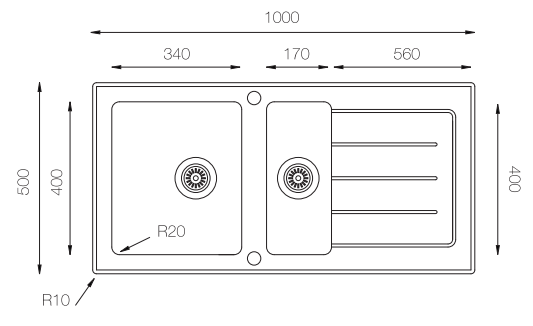



---

FINCLY HOUSE  
FINCLY AVENUE  
MILDENHALL  
BURY ST EDMUNDS  
IP28 7BG  
TEL 0208 539 77 16  
e-mails:  
info@ukinox.co.uk  
sales@ukinox.co.uk  
web site: www.ukinox.co.uk

---

